

Negative Bias in ASFM Discharge Measurements in Short Intakes -Transducer Spacing

*J.R. Marko and D. D. Lemon
ASL AQFlow Inc.
Sidney, B.C.
Canada*

1. Introduction

The Acoustic Scintillation Flow Meter (ASFM) measures flow velocity in directions perpendicular to pairs of parallel acoustic beams. In its simplest hydroelectric power plant applications, the ASFM's acoustic beams originate from horizontally-aligned pairs of adjacent transducers mounted on intake walls or on the vertical members of frames designed to fit into intake gate slots. The generated horizontal acoustic beam signals are received on the other side of the intake by matching and directly opposing pairs of receiving transducers. Time delays, τ , corresponding to optimal cross-correlations of the fluctuating signal amplitudes at the adjacent receivers are assumed to be related to the component of the fluid velocity, \mathbf{v} , which parallels the vector separation, \mathbf{d} , of the parallel beams by the relationship:

$$\tau = |\mathbf{d}|/(\mathbf{v}\cdot\mathbf{d}/|\mathbf{d}|). \quad (\text{Eq. 1})$$

This relationship is based upon Taylor's advected turbulence hypothesis which allows us to assume that the observed temporal fluctuations in received signal amplitude arise from refractive index changes caused by the drift of essentially the same eddies across adjacent acoustic paths. A detailed theory of these signal fluctuations, first developed for electromagnetic wave propagation in the atmosphere (Lee and Harp, 1969; Lawrence et al., 1972) and then for acoustic waves in liquid media (Farmer and Clifford, 1986) has been used in the development of demonstrated capabilities (Lemon and Farmer, 1990; Lemon, 1995) for ASFM flow measurements. This theory is based upon the assumed presence of eddies with dimensions slightly smaller than the size of a Fresnel zone, $(\lambda L)^{-5}$, where λ and L , respectively, denote the acoustic wavelength and cross-channel path length. In ASFM applications, such eddies have been assumed to be associated with inertial sub-ranges of homogeneous, isotropic turbulent flows.

Given the direct linkage of the measured time delays to the parameter \mathbf{d} , Eq. 1 dictates that the attained accuracies in velocity (and ultimately in total volume flow rates, Q), cannot exceed those achieved in specifying the velocity-paralleling component of the separation of the two acoustic paths employed in each measurement. Consequently, to achieve 1% accuracy targets in applications to short intake measurements dictates that the nominal 35 mm separations of adjacent ASFM paths and, hence, of the associated pairs of transmitting and receiving transducers should be known to an accuracy better than 0.5% or, roughly, 0.18 mm. Suspicions of the presence of a negative bias, i.e. a tendency to underestimate flow, in several past hydroelectric ASFM applications have motivated a detailed review of all relevant sources of error in the ASFM system and in its processing

protocols. This report describes recent efforts to quantify uncertainties arising from inaccuracies in transducer and acoustic path spacing.

2. Methodology and Results

2.1 Laboratory measurements

Originally, prior to intensive scrutiny of all accuracy limitations, transducer separation issues were addressed by accepting transducer manufacturer assurances that individual transducers could be encased in compact equilateral triangle arrays (Figure 1) with pairwise separations accurate to about 0.08 mm or to better than 0.25 % of the nominal 35.00 mm design spacings between the centres of adjacent transducers. Caliper measurements on a prototype unit, produced with clear epoxy potting material to allow visual checking of this assumption, confirmed this conclusion for the separations of the geometric centers in this one unit.

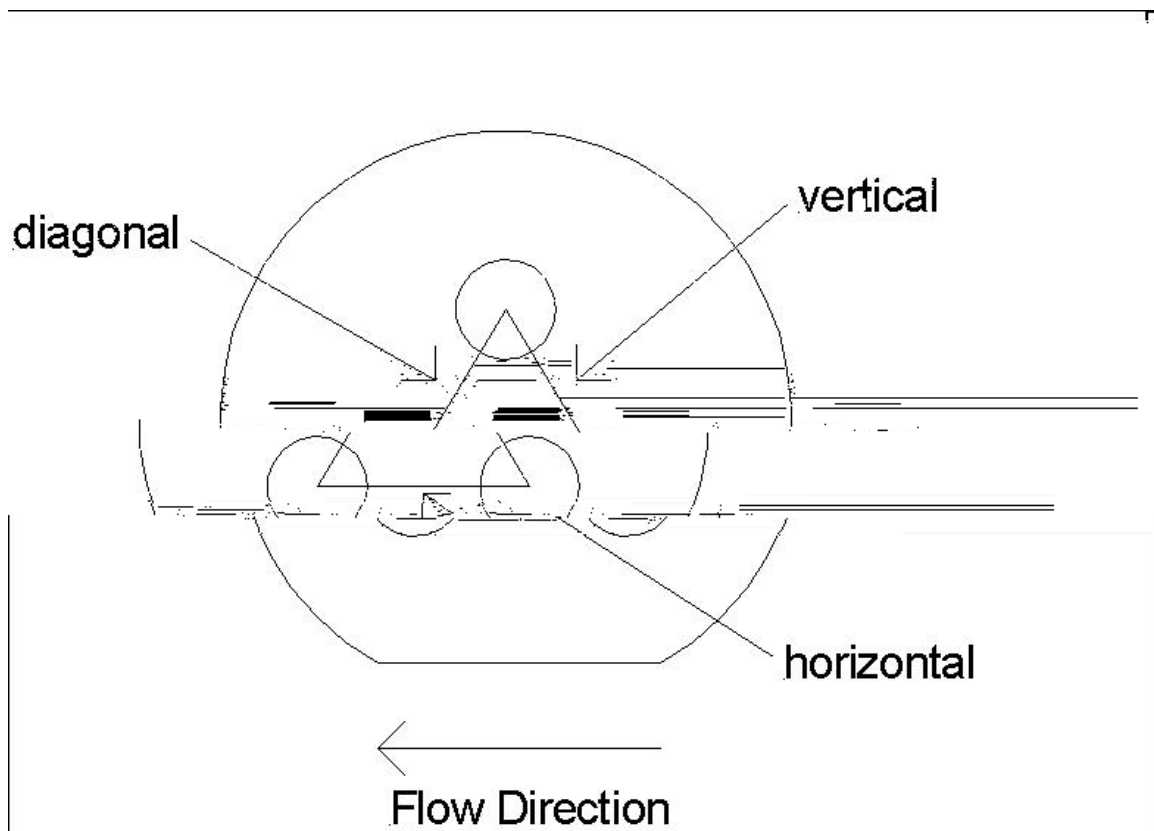

Figure 1. Schematic illustration of the triangular array of transducers incorporated in each ASFM transmitting or receiving unit. The included labeling denotes the terminology used in the text to identify each of the 3 different transducer pairings (horizontal, diagonal and vertical) as defined relative to the indicated flow direction.

The initiation of an error analysis program necessitated in-house calibrations to verify that similar conclusions were applicable to separations between the acoustic centres, as defined as the point on each transducer face which intersects the symmetry axis of its beam pattern, for any given transmitting or receiving unit. These calibrations were carried

out in a $1\text{ m} \times 1\text{ m} \times 1\text{ m}$ water-filled test tank using a fixed single transmitter and a horizontally movable receiver mount which allowed near simultaneous measurements of the phases of pulsed transmitter signals as received by each receiver of a tested pair as a function of the horizontal position of the receiver relative to the axis of the orthogonally incident pulsed acoustic beam. Beam crossing points were established for each receiving transducer by fitting the obtained phase and horizontal position data to a theoretical relationship. Differences between the crossing points of the two members of the pair yielded, directly, the corresponding separation of the transducers. Measurement repeatability was estimated from multiple measurements made on randomly selected units, both with and without removal of tested units and the test apparatus from the tank, over various time intervals as large as several months. The mean difference in such measurements was 0.08 mm or about 0.25% of the mean spacing. The largest repeat differences were less than 0.2 mm.

The described measurement technique has, thus far, been applied primarily to two different types of transducers. One of these types, Type A, was produced for use in early implementations of the ASFM instrument and prior to active recognition of possible significant distinctions between the acoustic and geometric centres of individual transducers. The second transducer type, Type B, was manufactured for use in ASL's new *ASFM Advantage* units and incorporated, from the onset, manufacturing and quality control adjustments to reflect results of accompanying ASL acoustic calibration measurements.

Type A calibrations indicated (Figure 2) that the distribution of measured spacings did, indeed, peak at the 35 mm target value although the overall mean of the measured spacings, 35.34 mm, was about 1% above the design value. Overall, ignoring the pronounced deviation posed by the narrow spike at 35.00 mm, the measured spacings corresponded to a Gaussian distribution with a width of 1.5 mm at half-height.

An equivalent distribution of separations measured for a larger number of the second (Type B) set of units is represented in Figure 3. In this case, the distribution was clearly centred on the 35.0 design value peak (the mean separation was 35.05 mm) and the great bulk of the measured values was distributed according to a much narrower (0.8 mm wide at half-height) Gaussian curve. As well, however, other separations were evident which fell well outside the central Gaussian envelope. The distribution of these outliers was also roughly describable by a Gaussian form with a half-height width, in this case, equal to about 6 mm.

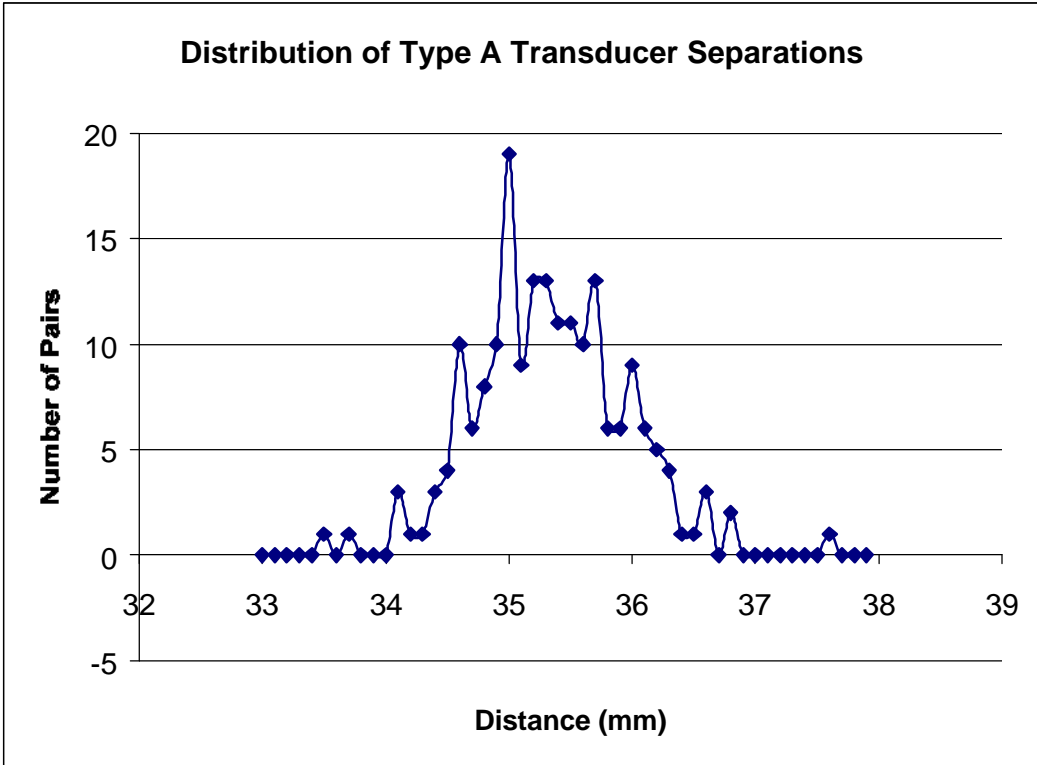

Figure 2. Distribution of measured separations for 190 pairs of Type A transducers used on ASL's in-house early ASFM instrument.

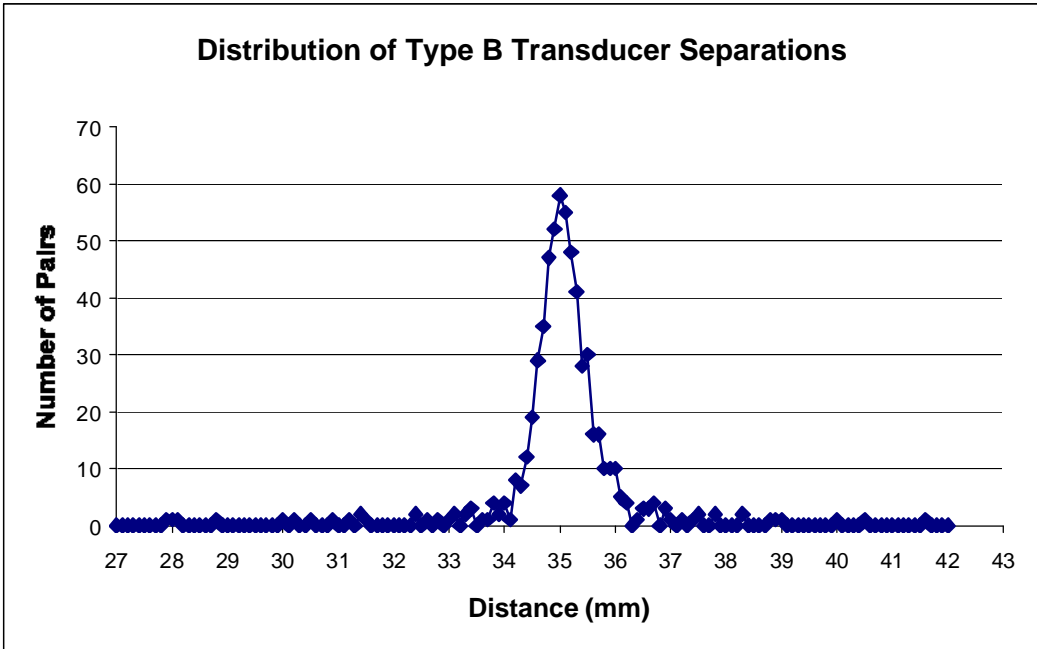

Figure 3. Distribution of measured separations for 603 pairs of Type B transducers designed for use on ASL's new ASFM Advantage instrument.

A possibly significant distinction between the two sets of calibration data was apparent in the considerably larger errors associated with fitting the Type A as opposed to Type B laboratory phase versus position data to the theoretical relationship. Specifically, for Type B units with separations describable by the narrower Gaussian component of the distribution of Figure 3, the magnitudes of the fitting errors were fully consistent with the precision of our phase estimation procedures. On the other hand, Type B pairs having spacings outside of the narrow distribution (i.e. separations > 36.2 mm or < 33.8 mm) were characterized by larger fitting errors, almost comparable in magnitude to those attained with Type A units.

2.2 Field Measurements

Given the simplicity and apparent validity of the described measurement scheme the laboratory-measured separations were assumed to be appropriate for quantifying the true acoustic spacings of the parallel beam paths associated with the ASFM measurement scheme. Nevertheless, given the circumstance that, in general, differences as large as a few per cent were characteristic of opposing transmitter and receiver pairs deployed on a given measurement path, some uncertainty remained as to the appropriate relationship between the “effective” path separation and the constituent transmitter and receiver pair separations. For simplicity and in accord with the symmetry of the underlying cross-covariance relationship with respect to the intake channel axis, path separation estimates were assumed to satisfy:

$$D = \frac{1}{2}(d_{\text{trans}} + d_{\text{rec}}), \quad (\text{Eq. 2})$$

where d_{trans} and d_{rec} , respectively, denote the magnitudes of the separations of the adjacent transmitting and receiving transducers.

Tests of this assumption and of the underlying laboratory determinations of acoustic spacings were carried out in January and February, 2002 during the course of turbine efficiency tests performed by the U.S. Army Corps of Engineers (USACE). These evaluations took place in two intakes of the hydroelectric facility at Lower Monumental Dam on the Snake River in eastern Washington State. A dedicated, ASL-owned ASFM unit was employed for the testing program, sharing a common deployment frame with the USACE’s ASFM instrument which was fully dedicated to the efficiency testing. Two arrays of 5 closely packed transducer transmit/receive units (Figure 4) were installed in directly opposing positions on opposite sides of the intake channel. This arrangement allowed ASFM flow measurements (utilizing the usual 3 different pairings of transmitting and receiving transducers as identified in Figure 1) along 5 different, immediately adjacent (separated by approximately 11 cm) cross-channel lines. With these lines traversing a nominally uniform flow regime (in the absence of fish screens), 3 m below the intake ceiling, it was reasonable to assume that differences in the velocities (or the underlying time delays) measured along adjacent lines with equivalently oriented adjacent transducer pairs could provide measures of differences in the corresponding transducer separations.

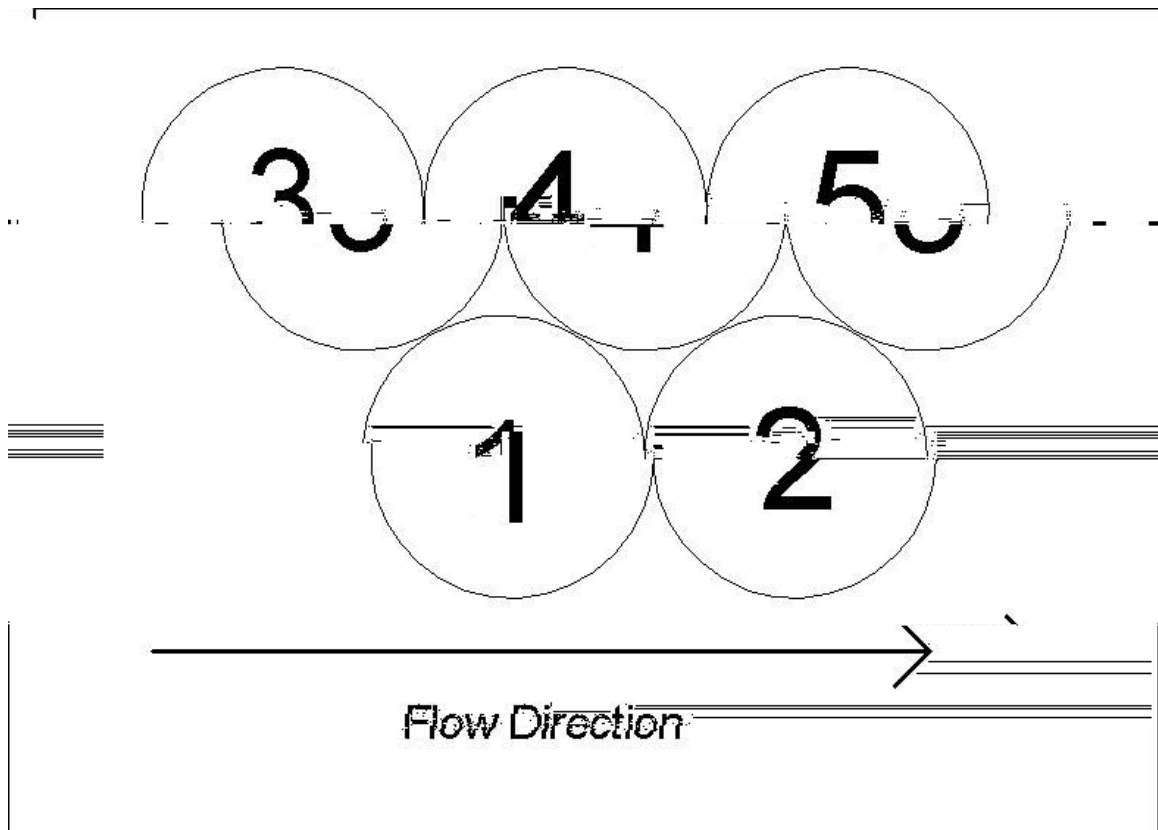

Figure 4. Schematic representation of the positioning of acoustic transmitter/receiver units in the Lower Monumental Dam studies. The labelling identifies each of the 5 separate measurement lines discussed in the text. In each of these lines, identical arrays were positioned in horizontally-opposing positions at a common vertical level. An equilateral triangular array of transducers as indicated in Figure 1 was contained within each indicated, approximately 10 cm diameter, unit.

Initial tests, carried out in late January, were focused exclusively on Type A units which were deployed at both ends of all 5 measurement lines. Individual units used in this study were selected to include an overall spread of individual pair separations sufficient to produce a 6% range of variability in the composite separation parameter D (Eq. 2). All runs were carried out in “on line” conditions in which power output was nominally constant, but small variations in power and flow could occur. To minimize the impacts of such adjustments on our comparisons, measurements were continually cycled or “inter-leaved” among the 5 measurement paths and averaging was carried out over long data-taking periods.

The Type A results presented here were obtained on January 21, 2002 and represent values averaged over 95 minutes of interleaved data-taking for the 5 measurement paths (19 minutes of data recorded for each path). The most immediately apparent feature of the results was the relatively small range of line-to-line variability in the velocities computed using an ASFM processing algorithm which explicitly assumed 35.00 mm separations for each transducer pair. For example, the largest difference among the individual path horizontal velocity components computed by this algorithm was not much larger than 1% or about 1/6 of the corresponding variability in the quantity D as

computed from Eq. (2) using laboratory-measured values of d_{trans} and d_{rec} . Subsequent analyses were focused on the more fundamental time delays, τ , measured by each transducer pair and, specifically, by the horizontal and diagonal pairs (i.e. those at the base and downstream sloping sides of the triangular array (Figure 1)) which most closely paralleled the measured flows (which, in all cases, were directed downward from the horizontal by an angle of, roughly, 25°). Results from these pairs were, because of this alignment, most heavily weighted in computations of overall line velocities

The horizontal and diagonal time delay results are presented in Figures 5a,b for all 5 measurement lines normalized to the line 5 results. The quantities on the horizontal axes in these Figures are the similarly normalized values (ratios) values for the quantities D_{hi} and D_{di} representing the respective horizontal (h) and diagonal (d) composite separations derived from Eq. 2 for the i^{th} measurement line. In each case, a solid line is included to represent equality in the measured time delay and composite separation ratios. Although, aside from a single outlier, the match-up with the equality assumption is marginally impressive in the diagonal case (Figure 5b), the horizontal results suggest this impression was almost certainly fortuitous and that no robust relationship exists between the means of the laboratory-measured transmitter and receiver pair separations and the ASFM-measured time delays. Overall, as well, the ASFM-measured time delays vary over a total range of 2 % which is only about one-third the size of the corresponding variability in the effective path spacing, D , as computed from laboratory-measured transducer separations.

To help understand these unexpected results, a second body of measurements was improvised in the field and carried out on February 19-20, during a second set of USACE efficiency tests at Lower Monumental Dam. This approach introduced Type B transducer units into the basic measurement array of Figure 4. The modified array was deployed in the intake (near to that used in the January testing) and differed from the earlier configuration by: an interchange of the positions of lines 3 and 4; retention in lines 4 and 5 of the original Type A transmit and receive units; and the replacement of the Type A units of lines 1, 2 and 3 by Type B units. Our choices of specific Type B units for inclusion on these lines were made to both:

- 1) assure inclusion of units containing pairs with strongly deviant spacings relative to the 35.00 mm design value. Such spacings ranged as low as 30.02 mm on the line 1 diagonal receiver pair and as large as 37.75 mm on the line 3 diagonal transmitter pair.
- 2) avoid any ambiguities involved in defining an appropriate path separation parameter (i.e. path separations could be given by a different, possibly more complicated, function of the laboratory-measured separations relative to Eq. 2) by insuring that one measurement line (line 2) was terminated by transmitting and receiving units in which all three transducer separations were within 0.15 mm of the 35.00 mm design/geometric spacing value.

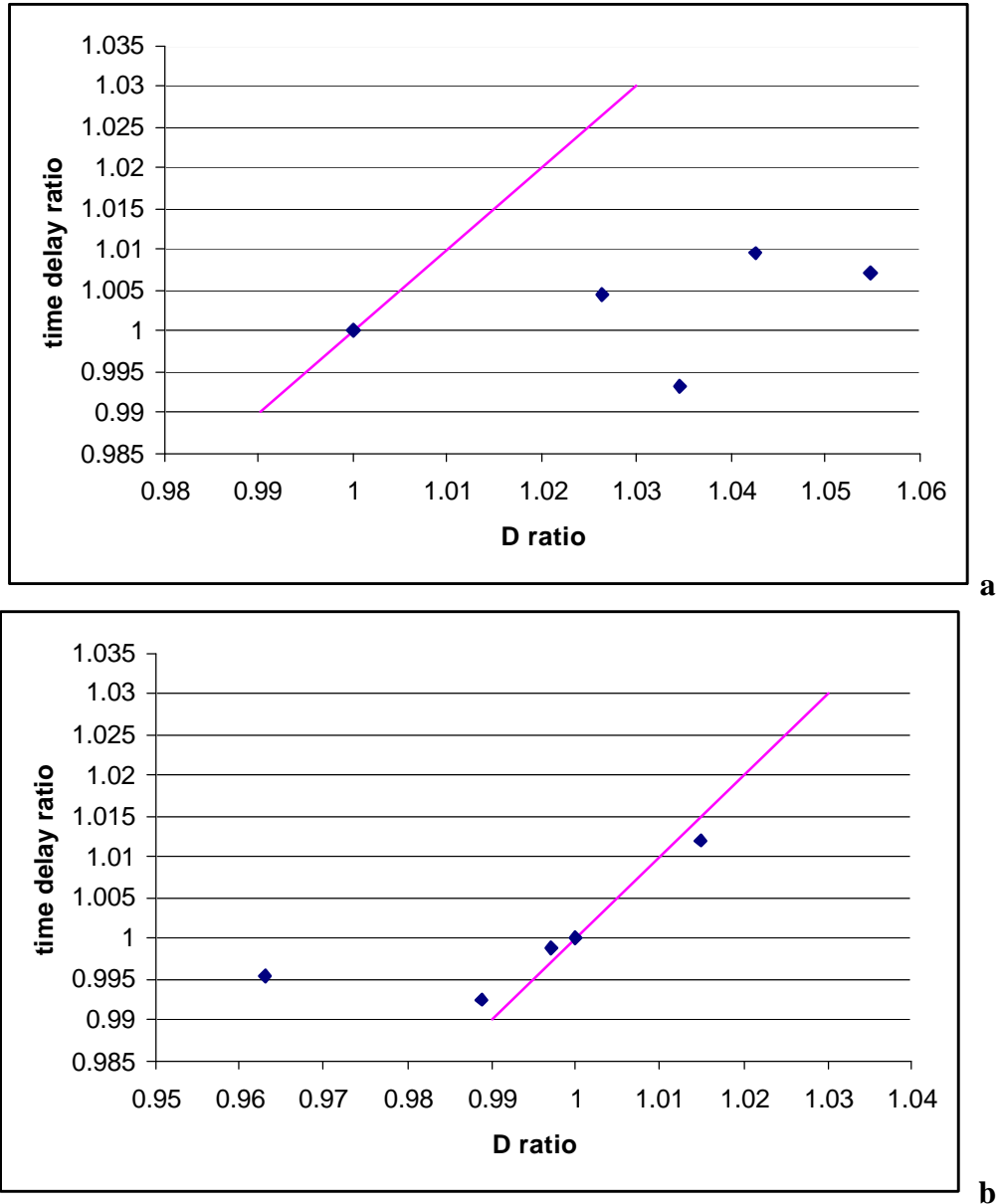

Figure 5. Plots of the measured (on January 21, 2002) ratios of time delays (vertical axes) on all measurement lines across the a) horizontal and b) diagonal transducer pairs (all relative to the time delay on line 5) as a function of the corresponding ratios (horizontal axes) of the acoustically measured mean transmitter + receiver spacings, D_{hi} and D_{di} . The included straight lines are representative of expectations assuming exact correspondence between the spacings implied by the flow-measured time delays and the mean spacing parameters, D_{hi} and D_{di} , derived from the acoustically measured spacings.

In the first case, data gathered with widely deviant transducer separations (i.e. belonging to the broader of the two Gaussian distributions identified in the distribution of Figure 3) provided an extreme test of the relative insensitivity of time delays to laboratory-measured transducer separations as inferred from the Type A testing (Figure 5). The second selection criterion provided some assurance that, because of the extremely small deviations of the contained pair separations from the 35.00 mm design value, the

effective spacings of all measurement paths on at least one measurement line would be extremely insensitive to possible variants of the definition of D (Eq.2). Consequently, comparisons of time delays relative to values measured in February along line 2 could be expected to provide a reasonable basis for estimating effective spacings, D_{eff} , for all other paths assuming both the validity of Eq.1 and uniformity of the velocity fields across the 5 measurement lines. This approach assumes that the coincidence of the peak of the Type B spacing distribution with the 35.00 mm design value and the close proximity of all spacings on the line 2 units to this value justifies setting D_{eff} to a value of 35.00 +/- 0.08 mm for the horizontal, diagonal and vertical time delay measurement paths on this line.

Unfortunately the measurement procedures in the mixed (Type A +Type B) transducer tests were complicated by differences in the acoustic signal sensitivities of the two transducer types. These differences necessitated use of unique, Type A or Type B, gain settings and, without immediate access to additional instrument components, precluded direct Type A/Type B comparisons in the interleaved simultaneous mode previously employed in the (January) measurements. Thus, in both the February 19 and 20 tests, about 25 minutes of data were recorded first on the Type A lines (4 and 5), followed by a 10-15 minute interlude of cabling and gain changes after which data were gathered with the Type B units on lines 1-3 for much longer periods (4.3 hours and 1.2 hour, respectively, on these two dates). Although, on both occasions, unit operation was maintained at the same nominal power level for the full measurement period, the non-simultaneity of the Type A and Type B measurements introduced some uncertainties into corresponding comparisons. Concerns in these respects were raised by noted 2.8 % mean differences between the ratios of Type A (lines 4 and 5) to Type B (lines 1-3) time delays as inferred for both the horizontal and diagonal pairs from, alternatively, the February 19 and 20 measurements. These differences were noted in spite of the fact that the corresponding day to day Type B to Type B and Type A to Type A mean time delay ratio differences were 0.5% and 0.4%, respectively. Consequently, in general, continuities of flow conditions between the respective Type A and Type B portions of both the February 19 and 20 measurement programs could not be assumed. Subsequent reviews of the limited amount of turbine power output data (available only for February 19) (see Figure 6) suggest changes of 1% or more in flow magnitude were likely to have occurred on both of these dates during the periods spanning the Type A and Type B measurement intervals. On the basis of the available turbine power output results, it was judged that the most reliable overall comparisons could be obtained by restricting considerations to Type A and Type B time delay data as gathered during, respectively, the 18:11-18:36, February 19 and 18:59-20:01, February 19 time intervals. These separate Type A and Type B measurement intervals, denoted on the power output plot of Figure 6, appeared to correspond to reasonably steady and common levels of power generation and are, thus, suggestive of sufficient flow continuity for valid time delay comparisons.

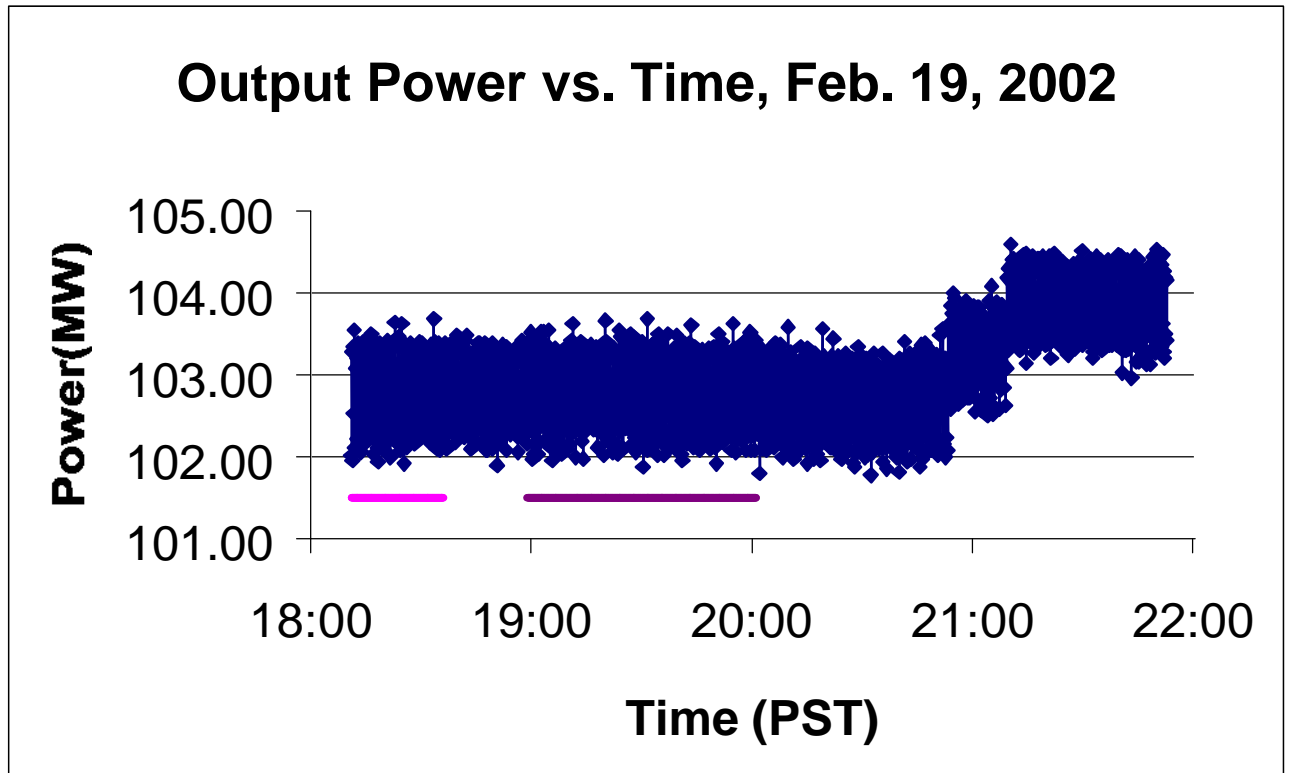
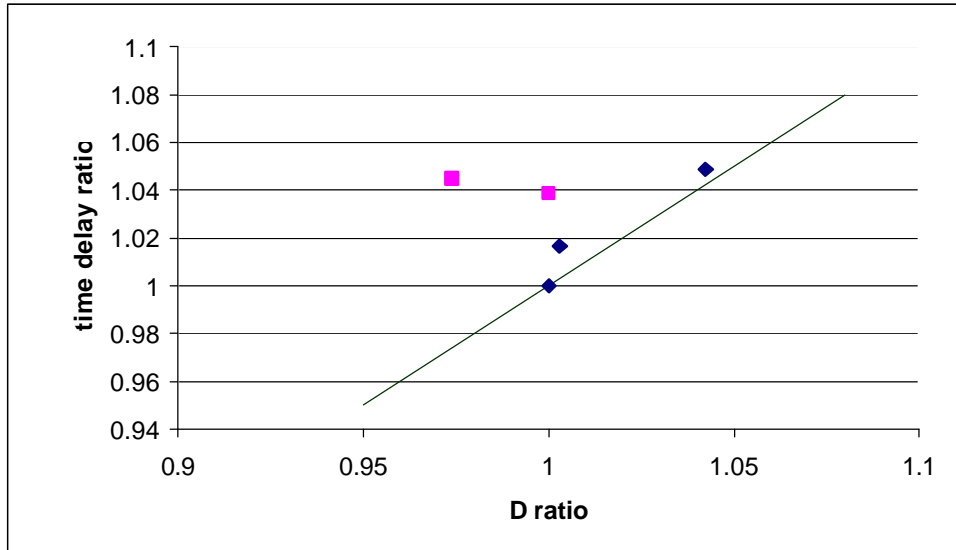
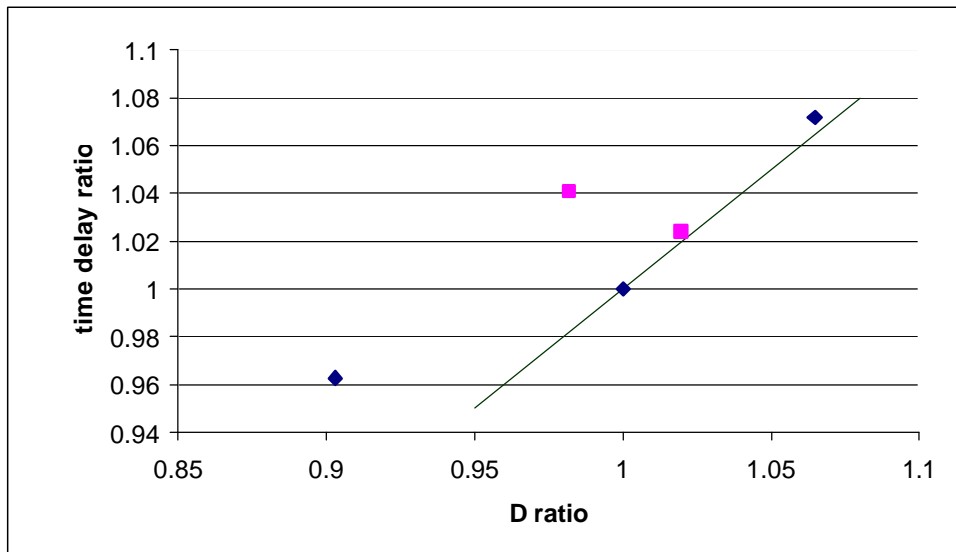

Figure 6. Turbine power output during the February 19, 2002 transducer spacing measurements at Lower Monumental Dam. The plotted points represent results of power measurements at 10 s intervals. Solid lines positioned below the plotted data denote the 18:11-18:36 and 18:59-20:01 time intervals used to obtain time delay data for, respectively, Type A and Type B transducers.

Results from these intervals are plotted in Figure 7a,b, again in the form of ratios of time delays as functions of the corresponding ratios of the path spacings D_{hi} and D_{di} . The separately plotted horizontal and diagonal path ratios are expressed relative (normalized) to corresponding quantities associated with the Type B units deployed on measurement line 2 to facilitate, as noted above, extraction of absolute path spacing estimates. The use of separate symbols for, respectively, Type A and Type B data points emphasizes the non-simultaneity of the respective data-taking and highlights the obvious differences between the results obtained for the two different transducer types.



a



b

Figure 7a,b. Ratios of time delays measured in the identified February 19 time intervals for the a) horizontal and b) diagonal pairs on the 5 individual measurement lines plotted as a function of the corresponding ratios (horizontal axes) of the quantities D_{hi} and D_{di} derived from laboratory acoustic measurements. All ratios are calculated with respect to corresponding quantities for the similarly oriented pairs on line 2 as described in the text. The diamonds denote points corresponding to lines 1-3 associated with Type B transducers while the squares correspond to the line 4 and 5 data gathered with Type A units previously employed in the measurements underlying Figures 5. The included straight lines are representative of expectations assuming exact correspondence between the spacings implied by the flow-measured time delays and the D_{hi} and D_{di} parameters.

The most apparent of these differences is the reasonably good correspondences achieved between the Type B time delay ratios and expectations, indicated by the solid lines, in terms of an equality of corresponding time delay and path separation ratios. Specifically, in contrast to the included and previous Type A results (see Figure 5), the

Type B time delay ratios all increase with increasing separation ratios and, with one exception, all lie close to the included equality line. It is noteworthy that this agreement was achieved in spite of deliberate choice of pairs for inclusion with problematically large laboratory-measured spacings. In fact, the only large deviation from the straight-line relationship was associated with measurements on line 1 utilizing diagonal pairs with laboratory-measured receiver and transmitter spacings of 30.02 mm and 33.30 mm, respectively. With one of these elements almost 5 mm shorter than the design value, deviations from a linear relationship between the time delay and laboratory-measured spacing were not an unexpected result.

3. Interpretations, Conclusions and Further Work

Overall, although the numbers of tested transducer pairs included in this initial study were too small for definitive conclusions, it would appear that laboratory measurements do provide a reasonably accurate basis for estimating the effective spacings of adjacent acoustic paths when applied to transducers characterized by appropriate phase behaviour in laboratory calibrations. This correspondence was achieved with the Type B units presently being used in the *ASF_M Advantage* instrument. Although further testing is required for confirmation, the results support the expectation that use of Type B units with pair separations belonging to the narrower Gaussian distribution depicted in Figure 3 does allow laboratory-measured spacing values to be employed in conjunction with Eq. 2 to provide ASF_M measurement path separations to an accuracy of approximately +/- 0.14 mm or about +/- 0.4%.

On the other hand, the ratios of time delays measured with Type A transducers not only show little evidence of proportionality to separation ratios but also lie consistently well above the expectation line based upon laboratory-determined separations. Given the relatively unit-independent nature of the results in Figures 5, one would have to conclude that essentially all Type A transducer separations evaluated in our field studies exceeded the 35.00 mm design value by somewhere between 3% to 4% (i.e. most separations were close to or above 36.0 mm) compared to an equivalent, roughly 1% mean elevation noted in the laboratory-measured values. These field data-based estimates need further corroboration, partly because of the somewhat smaller, 1.5% to 2 %, design value exceedances which were deduced from February 20 data gathered in the absence of equivalent confirmation (Figure 6) of flow stability. Clarification of this issue is, of course, directly relevant to interpretation of measurements made with ASF_M instruments containing Type A transducers. In particular, the suggested possibility of 1.5% to 4 % underestimation of acoustic path spacings would, by itself, account for much of the negative bias which has been suggested to be present in several prior ASF_M intake flow velocity measurements.

Further measurements and analyses are presently underway to explain the observed sensitivity of laboratory- and field-spacing estimate correspondences to transducer design. This effort includes theoretical work directed at advancing quantitative understanding of the relationship between the effective spacings of adjacent acoustic paths in ASF_M measurement lines and the separations of the acoustic centers in the

associated pairs of transmitting and receiving transducers. At present, evidence from reviews of individual transducer designs and from the above-noted comparisons of laboratory phase measurements suggests that the noted inconsistencies may be associated with internal reflections and interference. These effects could have introduced a range sensitivity into the measured spacings at the short ranges normally utilized in our laboratory procedures. Laboratory re-measurements at larger ranges and other changes will test this hypothesis, prior to additional, more extensive, field measurements. The latter effort will include interleaved, near simultaneous, Type A and Type B measurements on adjacent lines.

Acknowledgements

The authors wish to express their appreciation to the U.S. Army Corps of Engineers and its staff including, in particular, Rick Emmert for facilitating use of the Lower Monumental Dam for the described study and in providing critical support and ancillary data.

References

- Farmer, D.M and S.F. Clifford, 1986. Space-time acoustic scintillation analysis: a new technique for probing ocean flows. *IEEE J. of Oc. Eng*, **11**, 42-50.
- Lawrence, R.S., G.R. Ochs and S.F. Clifford, 1972. *Applied Opt.* **11**. pp 239.
- Lee, R.W. and J.C. Harp, 1969. Weak scattering in random media, with applications to remote probing. *Proc. IEEE*, **57**, 375-406.
- Lemon, D.D., 1995. Measuring intake flows in hydroelectric plants with an Acoustic Scintillation Flowmeter, Proceedings of WATERPOWER '95, An International Conference on Hydropower, San Francisco, 2039-2045.
- Lemon, D.D. and D.M Farmer, 1990. Experience with a multi-path scintillation flowmeter in the Fraser Estuary. Proc. of the IEEE Fourth Working Conference on Current Measurement, 290-298.